

10/17/2007

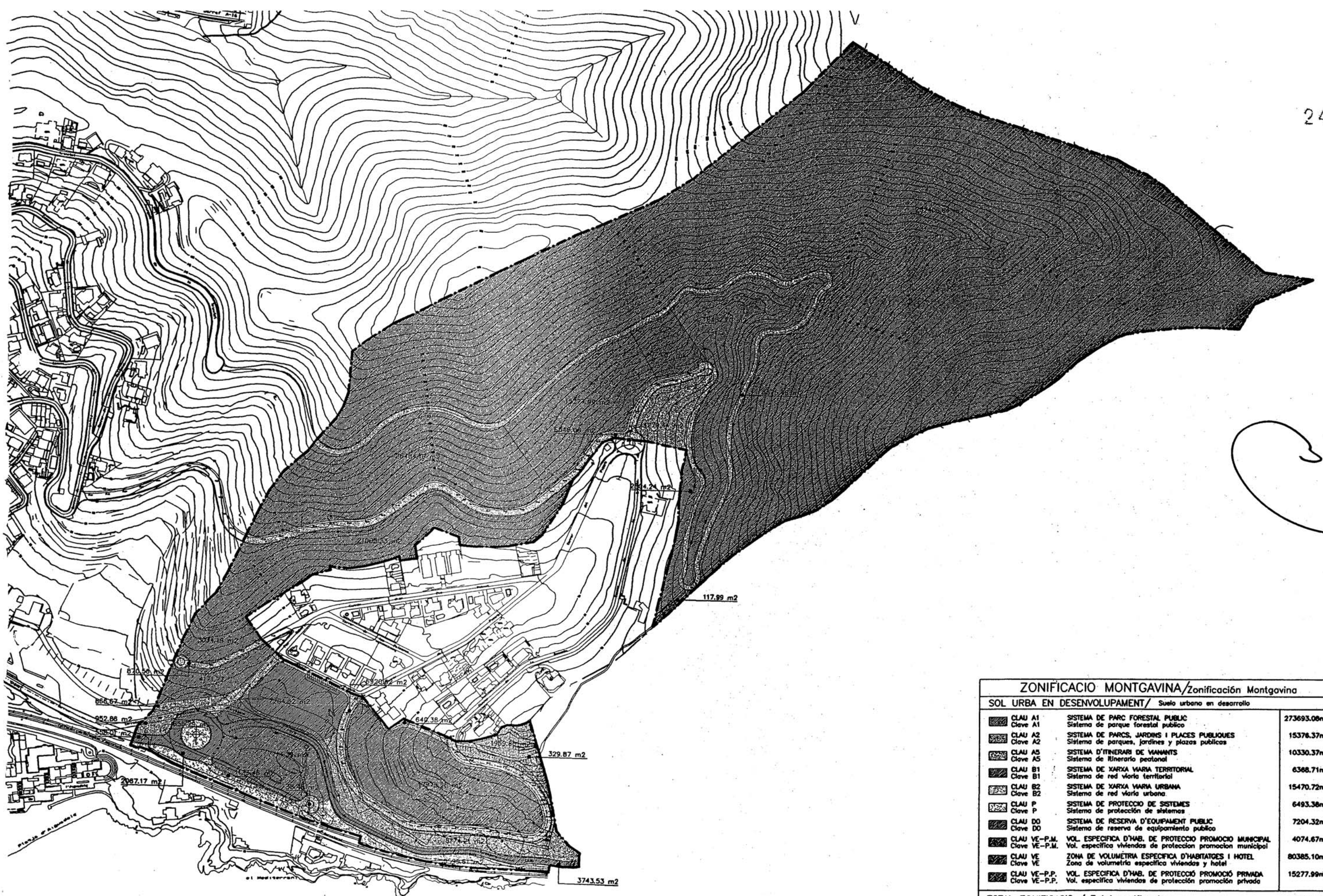

ZONIFICACIO MONTGAVINA / Zonificación Montgavina			
SOL URBA EN DESENVOLUPAMENT / Suelo urbano en desarrollo			
	CLAU A1 Clave A1	SISTEMA DE PARC FORESTAL PUBLIC Sistema de parque forestal public	273693.00m ²
	CLAU A2 Clave A2	SISTEMA DE PARCS, JARDINS I PLACES PUBLICUES Sistema de parques, jardines y plazas publicas	15376.37m ²
	CLAU A5 Clave A5	SISTEMA D'ITINERARI DE MANANTS Sistema de Itinerario peatonal	10330.37m ²
	CLAU B1 Clave B1	SISTEMA DE XARXA VIARIA TERRITORIAL Sistema de red viaria territorial	6368.71m ²
	CLAU B2 Clave B2	SISTEMA DE XARXA VIARIA URBANA Sistema de red viaria urbana	15470.72m ²
	CLAU P Clave P	SISTEMA DE PROTECCIO DE SISTEMES Sistema de protección de sistemas	6493.38m ²
	CLAU D0 Clave D0	SISTEMA DE RESERVA D'EQUIPAMENT PUBLIC Sistema de reserva de equipamiento publico	7204.32m ²
	CLAU VE-P.M. Clave VE-P.M.	VOL. ESPECIFICA D'HAB. DE PROTECCIO PROMOCIO MUNICIPAL Vol. especifica viviendas de protección promoción municipal	4074.67m ²
	CLAU VE Clave VE	ZONA DE VOLUMETRIA ESPECIFICA D'HABITATGES I HOTEL Zona de volumetria especifica viviendas y hotel	80385.10m ²
	CLAU VE-P.P. Clave VE-P.P.	VOL. ESPECIFICA D'HAB. DE PROTECCIO PROMOCIO PRIVADA Vol. especifica viviendas de protección promoción privada	15277.99m ²
TOTAL ZONIFICACIO / Total zonificación			434674.71m²

Revisament



ZONIFICACIO MONTGAVINA / Zonificación Montgavina		
SOL URBA EN DESENVOLUPAMENT / Suelo urbano en desarrollo		
CLAU A1 Clave A1	SISTEMA DE PARC FORESTAL PUBLIC Sistema de parque forestal público	273693.08m2
CLAU A2 Clave A2	SISTEMA DE PARCS, JARDINS I PLACES PUBLICUES Sistema de parques, jardines y plazas públicas	15376.37m2
CLAU A5 Clave A5	SISTEMA D'ITINERARI DE VIANANTS Sistema de itinerario peatonal	10330.37m2
CLAU B1 Clave B1	SISTEMA DE XARXA VARIA TERRITORIAL Sistema de red vial territorial	6368.71m2
CLAU B2 Clave B2	SISTEMA DE XARXA VARIA URBANA Sistema de red vial urbana	15470.72m2
CLAU P Clave P	SISTEMA DE PROTECCIO DE SISTEMES Sistema de protección de sistemas	6493.38m2
CLAU D0 Clave D0	SISTEMA DE RESERVA D'EQUIPAMENT PUBLIC Sistema de reserva de equipamiento público	7204.32m2
CLAU VE-P.M. Clave VE-P.M.	VOL. ESPECIFICA D'HAB. DE PROTECCIO PROMOCIO MUNICIPAL Vol. específica viviendas de protección promoción municipal	4074.67m2
TOTAL ZONIFICACIO / Total zonificación		339011.62m2

Cl. 3 / January



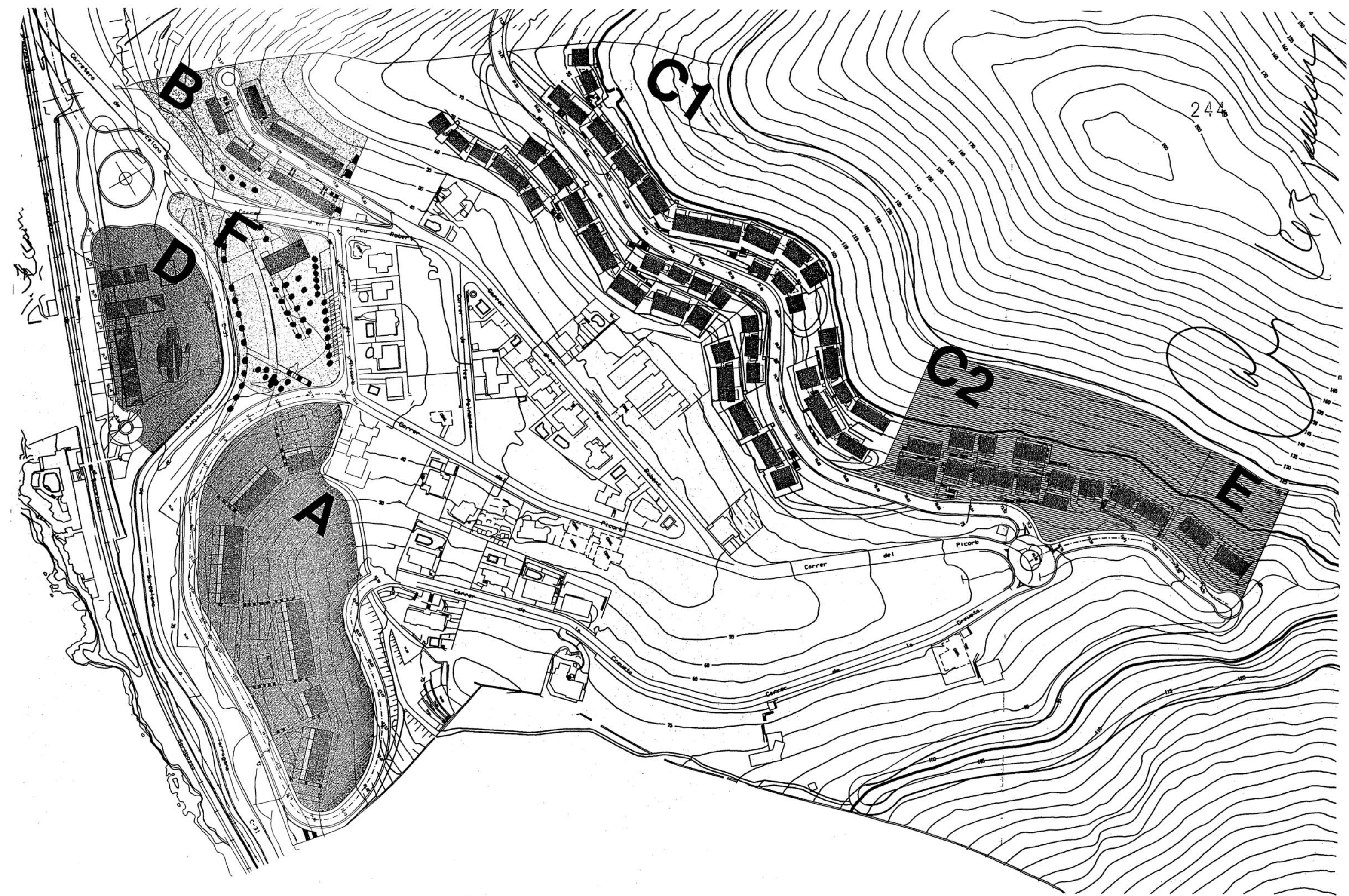

pl. 13 jaume

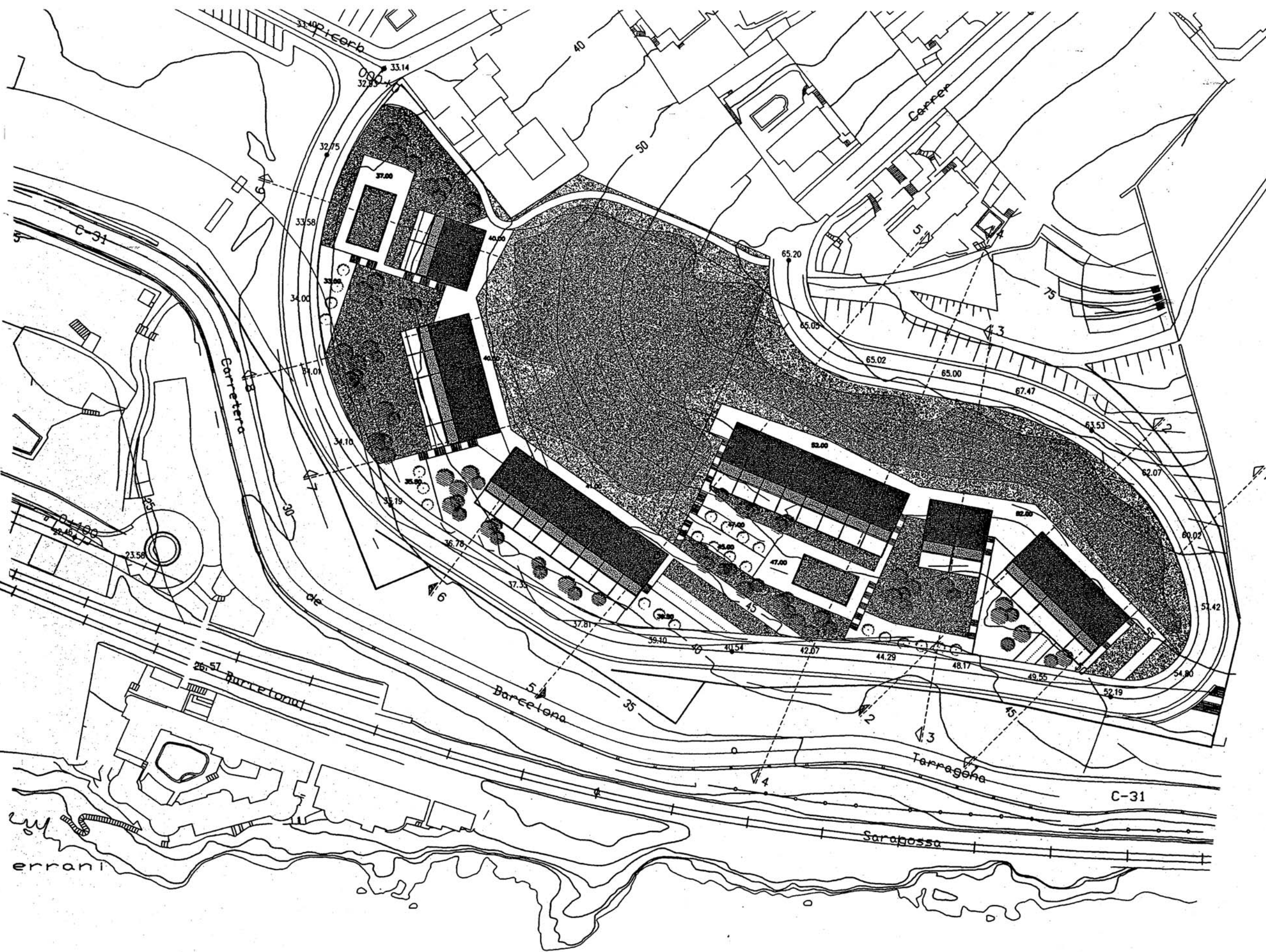
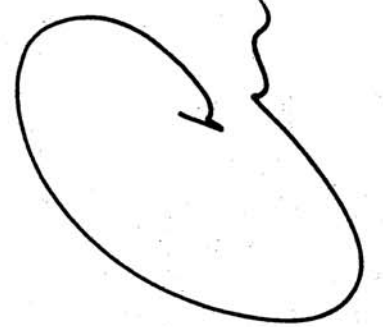

ca. 3 jansuny

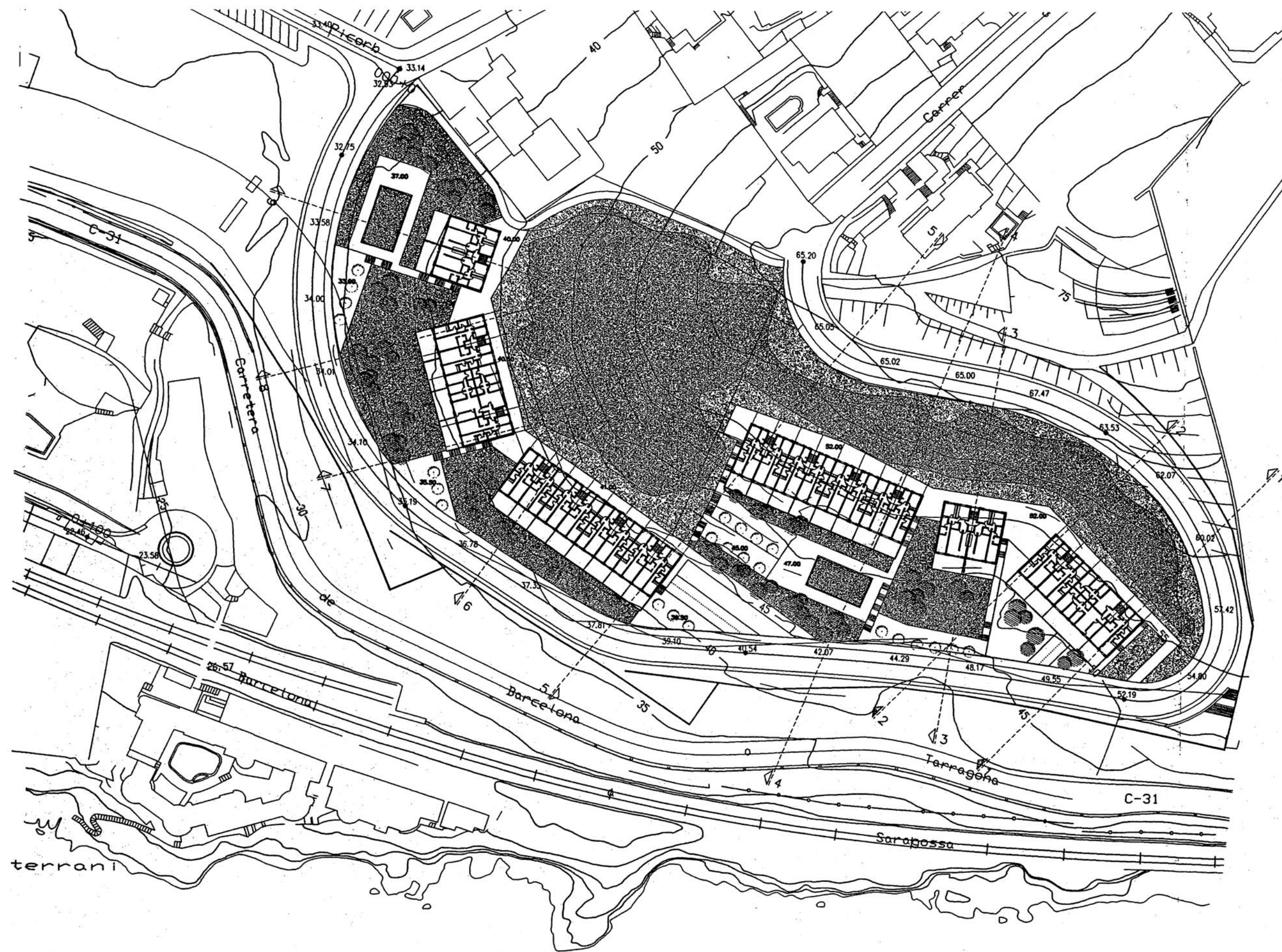

ca. 3 jansuny

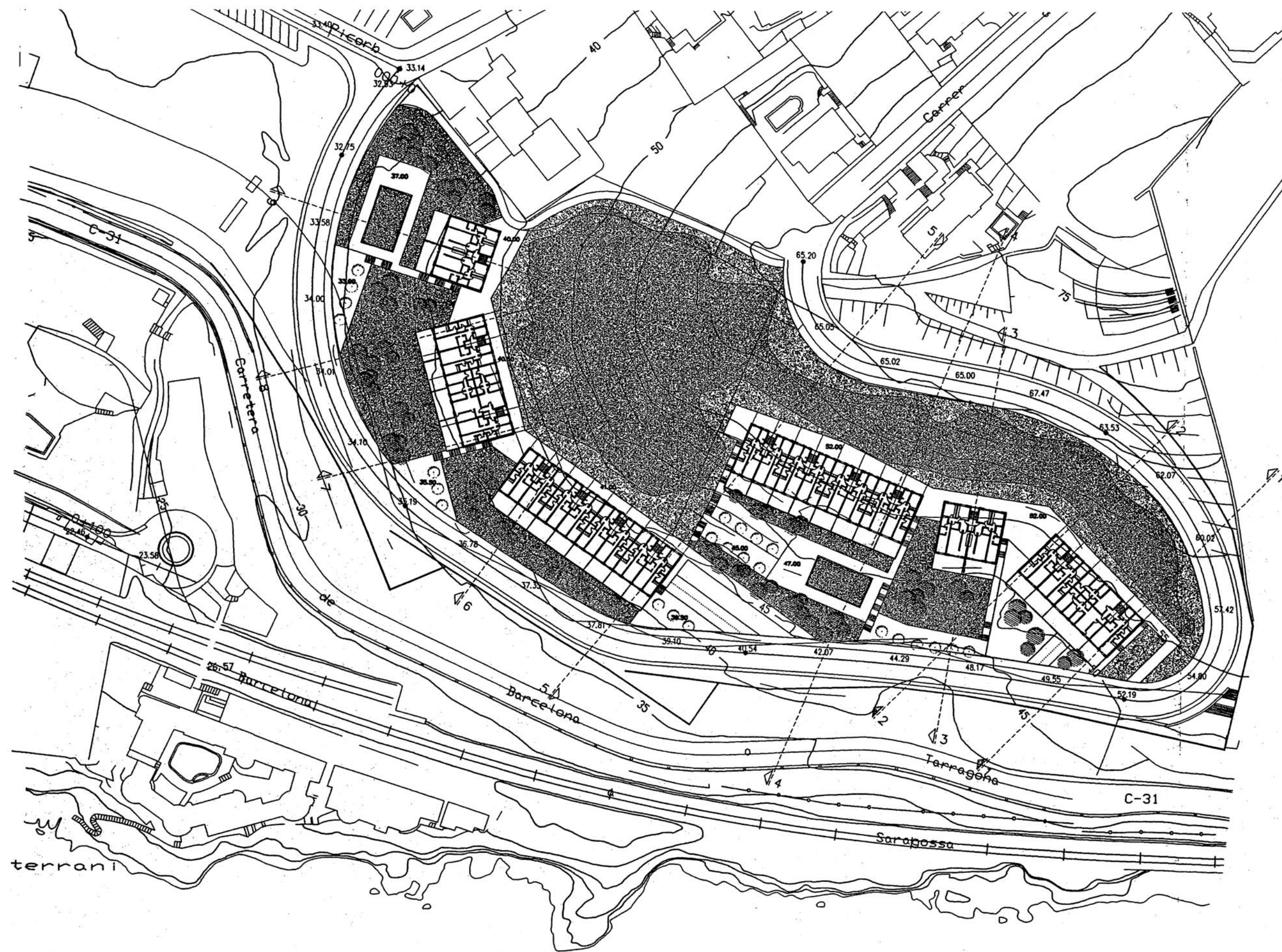

0,3 / summer

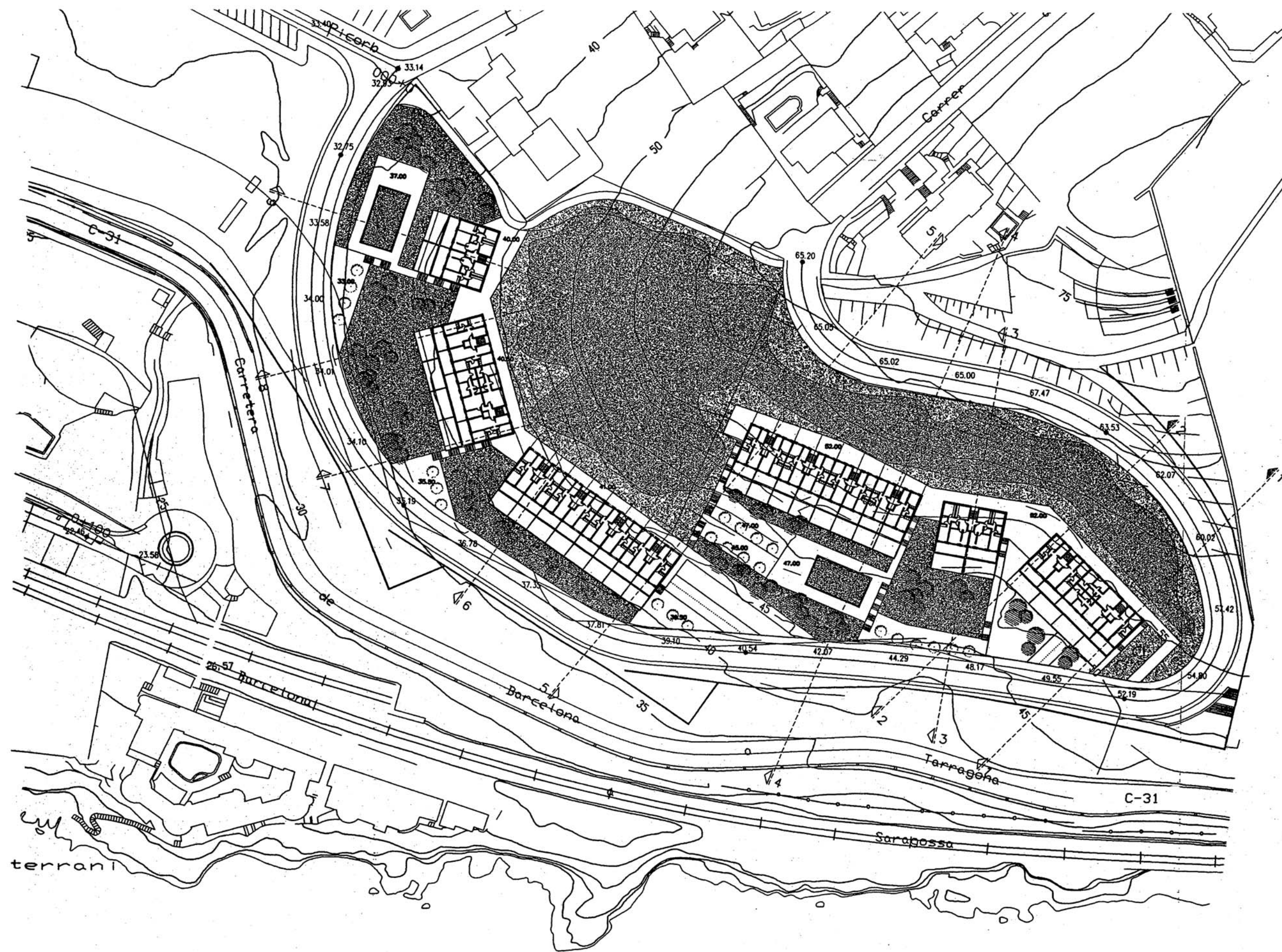
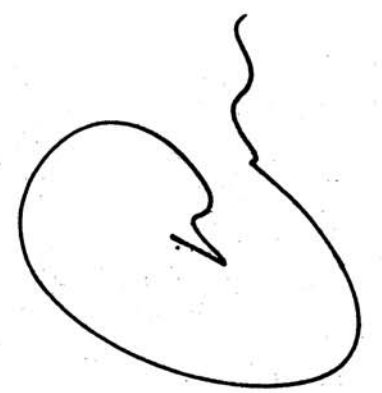

terrani



C.13 summary

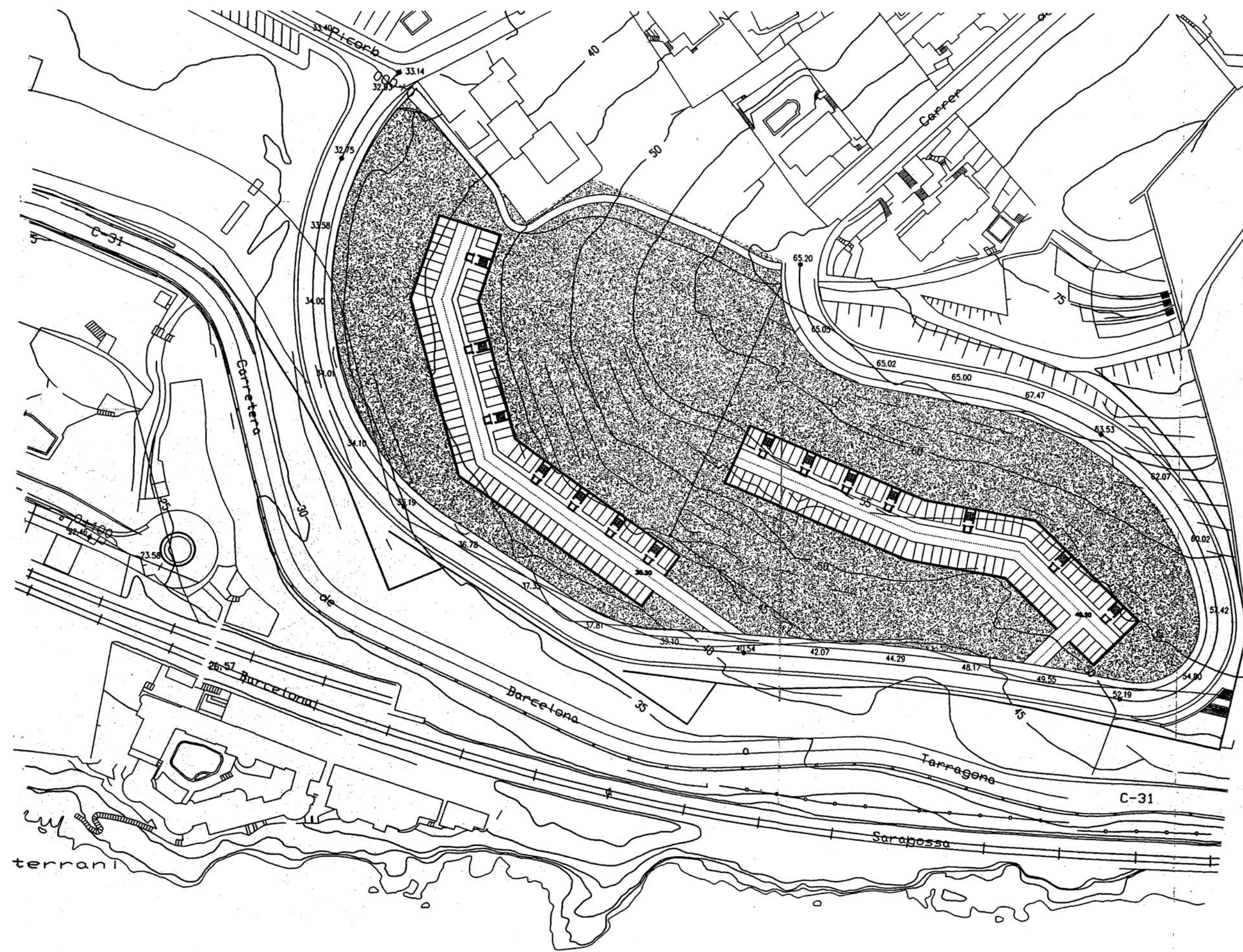

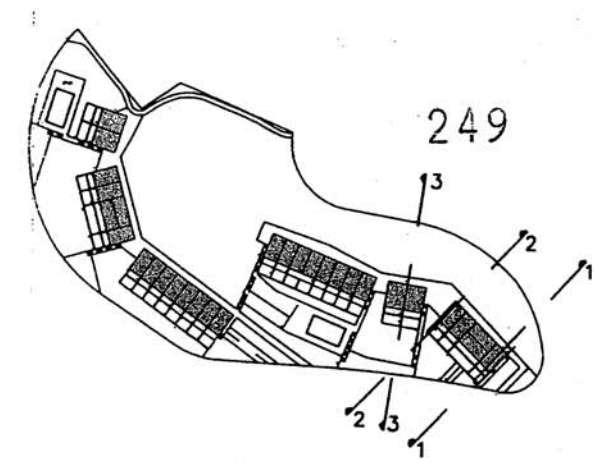
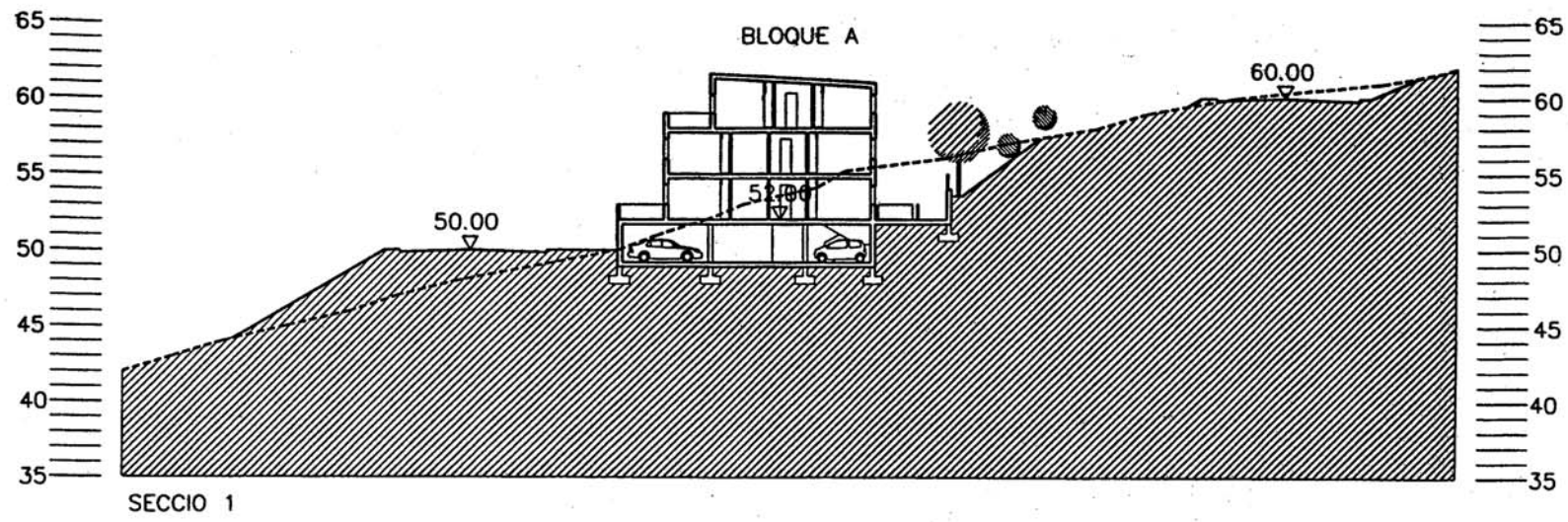

CE.3 / summary

